



## Classic Belt Bag - Style #9876

SP2021, 2020-2021, OTHER (Student work outside of classes)

## Summary



Classic Belt Bag

Name	Classic Belt Bag
Style No.	9876
Description	A timeless belt bag with a lined interior pocket, an included matching belt, and D-ring tabs for an attachable cross body strap.
Division	OTHER (Student work outside of classes)
Season	SP2021
Year	2020-2021
Size Scale	<input checked="" type="checkbox"/> O/S -Sample size
	<input type="checkbox"/> O/S
AM 380 Student Name	Jared Tarzian
Developer (Your name)	Jared Tarzian
Factory	CSU Factory
COO	USA
Main Fabric	Cow Leather
New/Carryover	New Style
Style Status	Approved
MSRP	169.99
Target Cost	50
Target Margin (%)	55
Created by/Author	05-10-2021 Jared Tarzian jaredjon@rams.colostate.edu



## Classic Belt Bag - Style #9876

SP2021, 2020-2021, OTHER (Student work outside of classes)

Images / uncategorized



Classic Belt Bag



# Classic Belt Bag - Style #9876

SP2021, 2020-2021, OTHER (Student work outside of classes)



● Atanado Auburn  
Custom Code: 8E552E  
**Atanado Auburn Colorway**



● Antique Ash  
Custom Code: 3D3937  
**Antique Ash Colorway**



## Classic Belt Bag - Style #9876

SP2021, 2020-2021, OTHER (Student work outside of classes)



● Bracken Brown  
Custom Code: 66422E  
**Bracken Brown Colorway**



# Classic Belt Bag - Style #9876

SP2021, 2020-2021, OTHER (Student work outside of classes)

## Images / Annotated Component Layout Image

### Components (10)

- B1** 3-4oz. Atanando Sides Leather (JJT)
- B2** 3-4oz. Atanando Sides Leather (JJT)
- B3** Turn Catch (JJT)
- B4** D-Rings (JJT)
- B5** Roller Buckle (JJT)
- B6** 3-4oz. Atanando Sides Leather (JJT)
- B7** 3-4oz. Atanando Sides Leather (JJT)
- B8** 3-4oz. Atanando Sides Leather (JJT)
- B9** Stretch Polyester (JJT)
- B10** 3-4oz. Atanando Sides Leather (JJT)

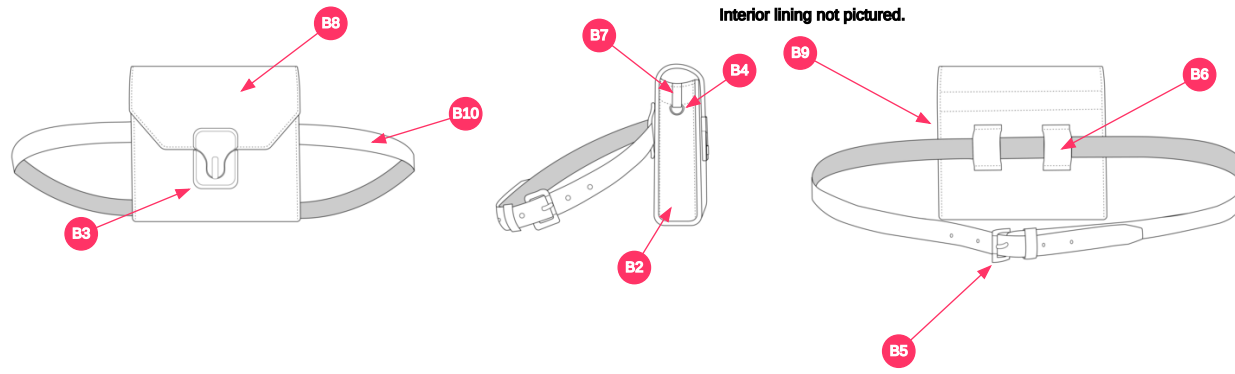

Component Layout



## Classic Belt Bag - Style #9876

SP2021, 2020-2021, OTHER (Student work outside of classes)

## Images / Annotated Component Layout Image

Components (4)

- B1** Double Cap Rivet (JJT)
- B2** Roller Buckle (JJT)
- B3** 3-4oz. Atanando Sides Leather (JJT)
- B4** 3-4oz. Atanando Sides Leather (JJT)



Belt Components



Components (4)

- B1** Double Cap Rivet (JJT)
- B2** Swivel Hook (JJT)
- B3** 3-4oz. Atanando Sides Leather (JJT)
- B4** 3-4oz. Atanando Sides Leather (JJT)

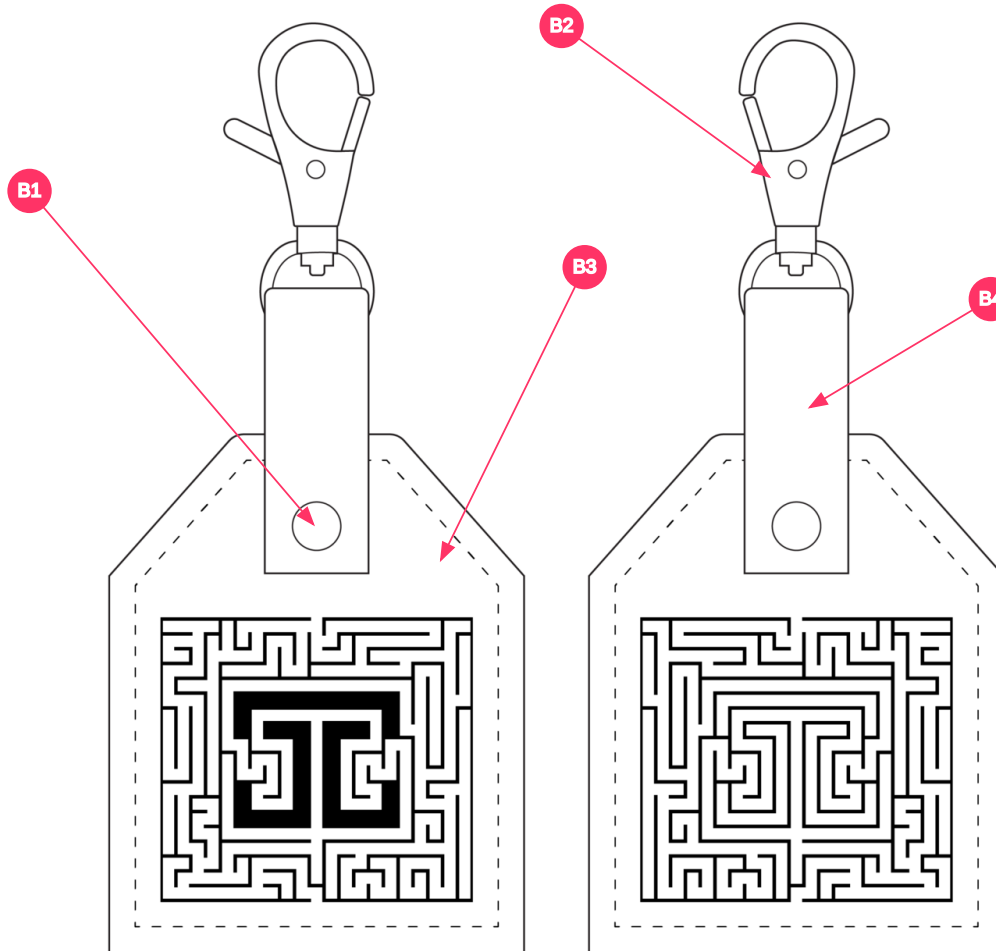

Keychain Components



# Classic Belt Bag - Style #9876

SP2021, 2020-2021, OTHER (Student work outside of classes)

## Images / Annotated Construction Detail Image(s)

Construction Details (4)

**C1** 205 Saddle Stitch

**C2** 205 Saddle Stitch

**C3** 205 Saddle Stitch

**C4** 205 Saddle Stitch

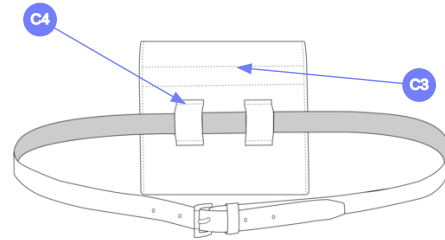
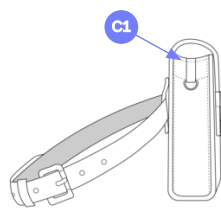
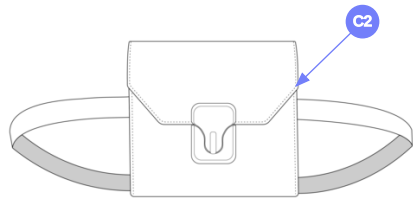

### Stitches & Seams



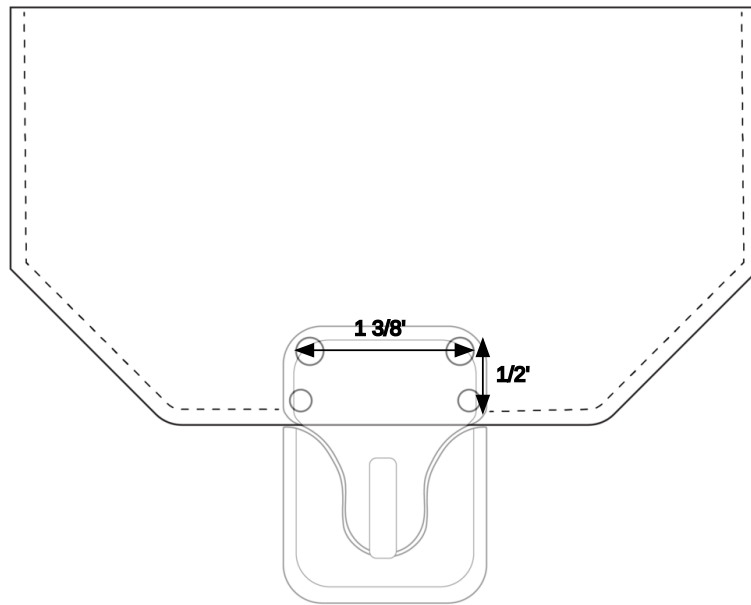

Turn Catch Hole Spacing



# Classic Belt Bag - Style #9876

SP2021, 2020-2021, OTHER (Student work outside of classes)

Points of measure (10)

- D1** Bag Height
- D2** Bag Top Width
- D3** Bag Bottom Width
- D4** Depth of Bag
- D5** Exterior Pocket Flap Length
- D6** Exterior Pocket Flap Width
- D7** Belt Loop Width
- D8** Belt Loop Length
- D9** Tab Width
- D10** Tab Length

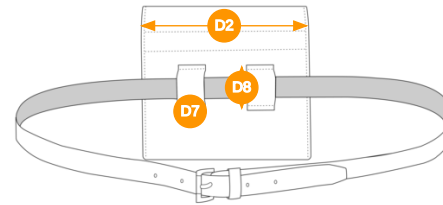
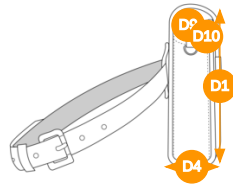
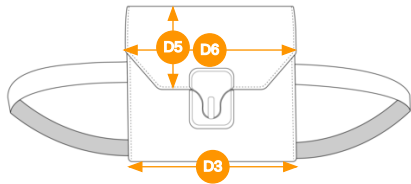

Points of Measure



Points of measure (2)

D1 Keychain Height

D2 Keychain Width

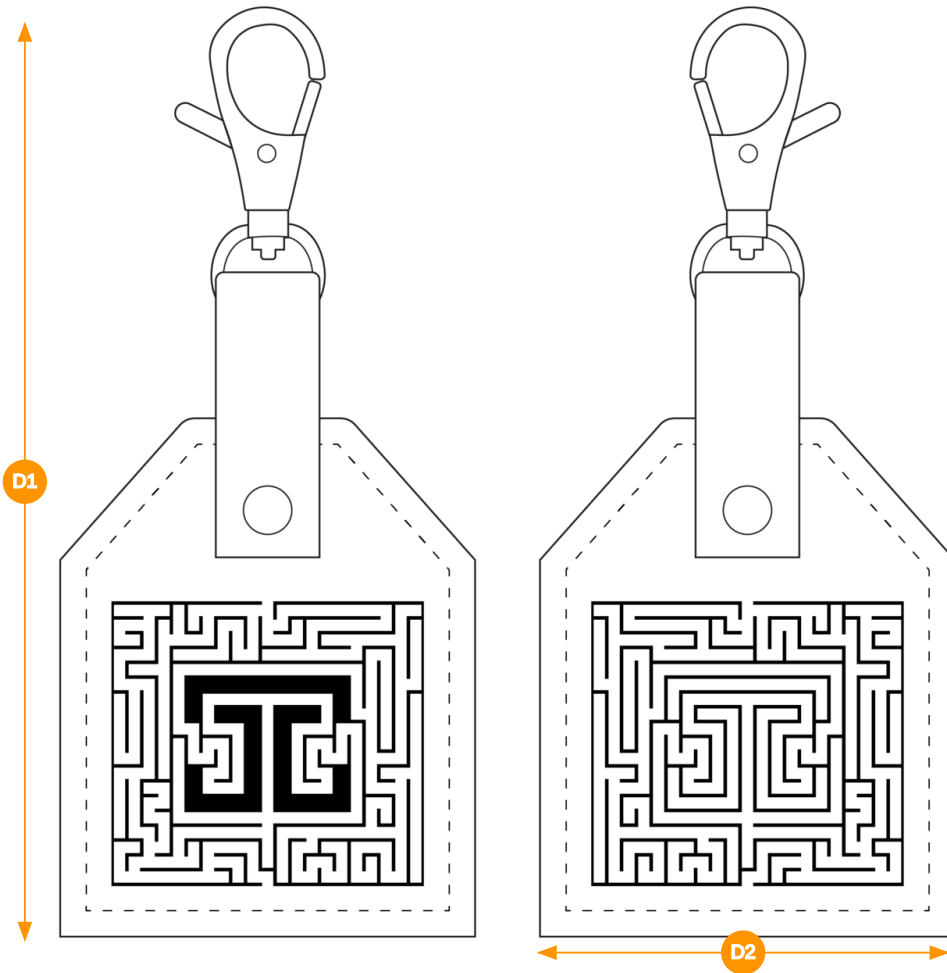

Keychain Components (copy)



Points of measure (2)

D1 Belt Length

D2 Belt Width (Or Height)



Belt POMS

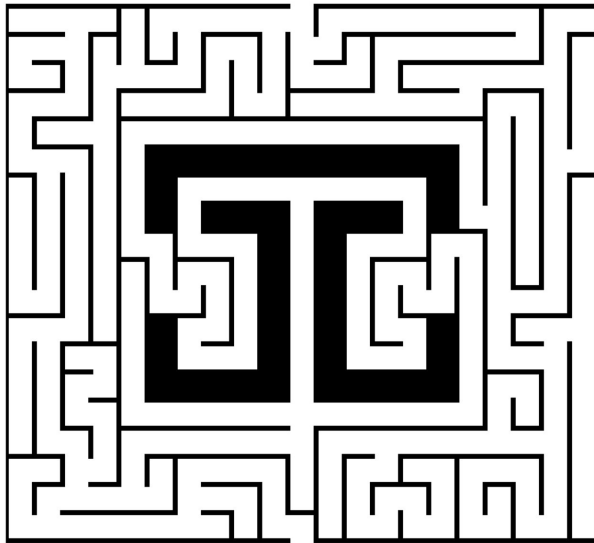

Keychain UV Print Front

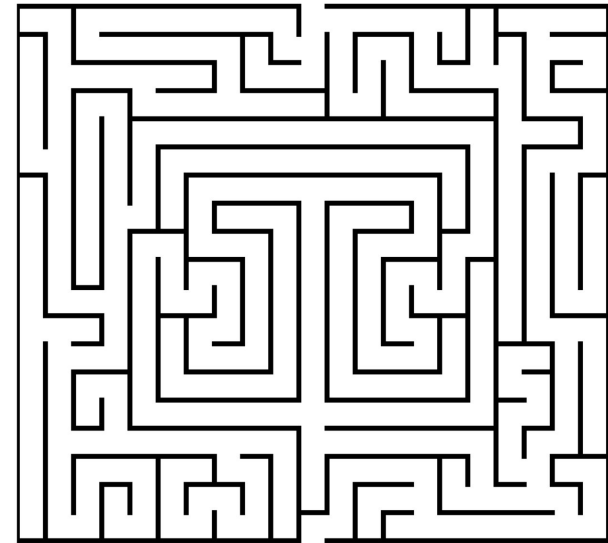

Keychain UV Print Back



Embossed Hang Tags



Cardboard Packaging

















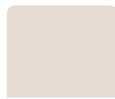

Envelope Dust Bag



# Classic Belt Bag - Style #9876

SP2021, 2020-2021, OTHER (Student work outside of classes)

THUMBNAIL	COMPONENT	QTY	ATANADO AUBURN CODE: 8E552E	ANTIQUE ASH CODE: 3D3937	BRACKEN BROWN CODE: 66422E
<b>BODY</b>					
1	 <p><b>3-4oz. Atanando Sides Leather (JJT)</b> CODE: d0Kd7 Placement: Exterior of bag, belt loops and belt. Supplier: To Be Determined Content (Fiber Content): Cow Leather Finishes: Chrome Tanned Dye Method: Piece Dyed Size: 18 sq. ft. COO: China</p>	0.3 /Pieces	 <b>Atanado Auburn</b> Custom Code: 8E552E Price: \$99.00	 <b>Antique Ash</b> Custom Code: 3D3937 Price: \$99.00	 <b>Bracken Brown</b> Custom Code: 66422E Price: \$99.00
<b>LINING</b>					
2	 <p><b>Stretch Polyester (JJT)</b> CODE: 9G7Bo Placement: Interior pocket Supplier: To Be Determined Content (Fiber Content): 96% Polyester, 4% Spandex Fabric Width: 48" Weight (GSM): 144 Dye Method: Piece Dyed COO: China</p>	0.15 /yd	 <b>Antique Ash</b> Custom Code: 3D3937 Price: \$3.89	 <b>Pale Blush</b> Custom Code: E5DBD3 Price: \$3.89	 <b>Antique Ash</b> Custom Code: 3D3937 Price: \$3.89
<b>TRIMS &amp; THREAD</b>					
3	 <p><b>Waxed Polyester Thread Cord (JJT)</b> CODE: oPpQM Placement: Everywhere Supplier: To Be Determined Content (Fiber Content): 100% Polyester Finishes: Waxed Dye Method: Piece Dyed Size: .05mm COO: China</p>	2 /yd	 <b>Black</b> Custom Code: 19-4003 Price: \$0.10	 <b>Black</b> Custom Code: 19-4003 Price: \$0.10	 <b>Black</b> Custom Code: 19-4003 Price: \$0.10
4	 <p><b>Turn Catch (JJT)</b> CODE: cng60 Placement: Top piece attached to bag flap, bottom piece attached to front of bag. Supplier: To Be Determined Content (Fiber Content): Zinc Alloy Finishes: Plated Size: 2x1/58" COO: China</p>	1 /Pieces	 <b>Brushed Brass</b> Custom Code: Metal Gradient 2 Color: Color Price: \$3.80	 <b>Soft Silver</b> Custom Code: Metal Gradient 3 Color: Color Price: \$3.80	 <b>Carbon Black</b> Custom Code: Metal Gradient Color: Color Price: \$3.80





# Classic Belt Bag - Style #9876

SP2021, 2020-2021, OTHER (Student work outside of classes)

THUMBNAIL	COMPONENT	QTY	ATANADO AUBURN CODE: 8E552E	ANTIQUE ASH CODE: 3D3937	BRACKEN BROWN CODE: 66422E
5 	<b>Double Cap Rivet (JJT)</b> CODE: wUa8l Placement: On belt, 1/2" from buckle opening with 1/2" spacing in-between the first and second rivet. Supplier: To Be Determined Content (Fiber Content): Zinc Alloy Finishes: Coated Size: 9x9x3mm COO: China	3 /Pieces	 Brushed Brass Custom Code: Metal Gradient 2 Price: \$0.07	 Soft Silver Custom Code: Metal Gradient 3 Price: \$0.07	 Carbon Black Custom Code: Metal Gradient Price: \$0.07
6 	<b>D-Rings (JJT)</b> CODE: Y6FUg Placement: Attach to tabs on the side of bag. Supplier: To Be Determined Content (Fiber Content): Iron Finishes: Plated Size: 1/2" Opening COO: China	2 /Pieces	 Brushed Brass Custom Code: Metal Gradient 2 Price: \$0.10	 Soft Silver Custom Code: Metal Gradient 3 Price: \$0.10	 Carbon Black Custom Code: Metal Gradient Price: \$0.10
7 	<b>Roller Buckle (JJT)</b> CODE: yX6ar Placement: Attach to belt Supplier: To Be Determined Content (Fiber Content): Zinc Alloy Finishes: Plated Size: 1" COO: USA	1 /Pieces	 Brushed Brass Custom Code: Metal Gradient 2 Price: \$1.99	 Soft Silver Custom Code: Metal Gradient 3 Price: \$1.99	 Carbon Black Custom Code: Metal Gradient Price: \$1.99
8 	<b>Swivel Hook (JJT)</b> CODE: 6f0IE Placement: Attach to keychain tab. Supplier: To Be Determined Content (Fiber Content): Iron Finishes: Brushed Size: 1x5/8" COO: China	1 /Pieces	 Brushed Brass Custom Code: Metal Gradient 2 Price: \$2.80	 Soft Silver Custom Code: Metal Gradient 3 Price: \$2.80	 Carbon Black Custom Code: Metal Gradient Price: \$2.80
PACKAGING					



# Classic Belt Bag - Style #9876

SP2021, 2020-2021, OTHER (Student work outside of classes)

THUMBNAIL	COMPONENT	QTY	● ATANADO AUBURN CODE: 8E552E	● ANTIQUE ASH CODE: 3D3937	● BRACKEN BROWN CODE: 66422E
9 	<b>Cardboard Packaging (JJT)</b> CODE: AIPyM Supplier: To Be Determined Content (Fiber Content): Recycled Cardboard Finishes: Coated Size: 7x6x3in. COO: China	1 /Pieces	-  Bright White Custom Code: 11-0601 Size: 10x8" Price: \$0.60	-  Bright White Custom Code: 11-0601 Size: 10x8" Price: \$0.60	-  Bright White Custom Code: 11-0601 Size: 10x8" Price: \$0.60
10 	<b>Envelope Dust Bag (JJT)</b> CODE: MOW3S Supplier: To Be Determined Content (Fiber Content): Velvet Dye Method: Piece Dyed Size: 10x7" COO: China	1 /Pieces	-  Antique White Custom Code: 11-0105 Size: 9x7" Price: \$0.45	-  Antique White Custom Code: 11-0105 Size: 9x7" Price: \$0.45	-  Antique White Custom Code: 11-0105 Size: 9x7" Price: \$0.45
11 	<b>Embossed Hang Tags (JJT)</b> CODE: cQNRB Placement: Attach to right D-ring tab. Supplier: To Be Determined Content (Fiber Content): Recycled Paper Finishes: Embossed Size: 2x2" COO: China	1 /Pieces	-  Bright White Custom Code: 11-0601 Price: \$0.25	-  Bright White Custom Code: 11-0601 Price: \$0.25	-  Bright White Custom Code: 11-0601 Price: \$0.25
Components <b>11</b>			Total <b>\$40.78</b>	Total <b>\$40.78</b>	Total <b>\$40.78</b>



128.

Belt Length



129.

Belt Width (Or Height)

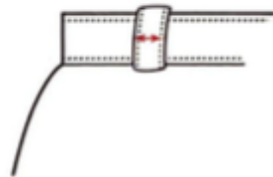

131.

Belt Loop Width

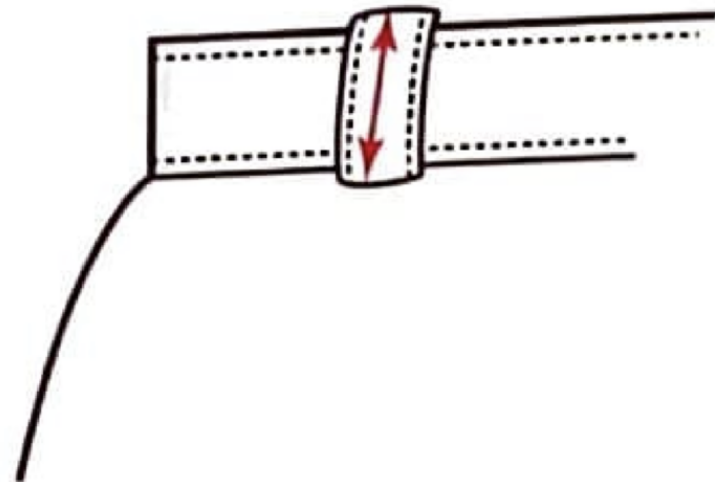

130.

Belt Loop Length



Sample Size: O/S

POINT OF MEASURE	CODE	HOW TO MEASURE	CRITICAL	TYPE	TOLERANCE	O/S
Bag Height	7SLQff	From bottom of bag to top of bag (highest points)	true	Full	1/2 in	6 1/4 in
Bag Top Width	X7BLXX	Lay flat and measure from edge to edge.	true	Full	1/4 in	6 in
Bag Bottom Width	B0HhXG	Lay flat and measure from edge to edge.	true	Full	1/4 in	6 in
Depth of Bag	3ybxry	Bottom width of bag, from the back to the front	true	Full	1/8 in	1 3/4 in
Exterior Pocket Flap Length	x3eDqP	Bottom edge of flap to peak of flap curl.	true	Full	1/8 in	3 in
Exterior Pocket Flap Width	E4gPfy	Measure edge to edge at widest post.	true	Full	1/8 in	6 in
Belt Length	128	A. Total - Measure from end of belt at buckle along center of belt to opposite end of belt, following contour. // B. Circumference - Measure from end of belt at buckle along center of belt to middle hole at opposite end	true	Full	1/4 in	38 in
Belt Width (Or Height)	129	Measure from edge of belt straight across to edge of belt. (Note: If belt is contoured, indicate points of measure on spec sheet.)	true	Full	1/8 in	1 in
Belt Loop Width	131	Measure belt loop from edge of belt loop straight across / horizontally to edge of belt loop. (Note: Fashion-forward or irregularly shaped belt loops may require further spec instructions. Indicate point of measure on spec sheet.)	true	Full	1/8 in	1 in
Belt Loop Length	130	Measure from top of belt loop straight down/vertically to bottom of belt loop along center of belt loop. (Note: Fashion-forward or irregularly shaped belt loops may require further spec instructions. Indicate points of measure on spec sheet.)	true	Full	0 in	1 7/8 in
Belt Loop Placement - Distance Between	QC5cgL	Measure inside edge to inside edge at widest point.	true	Full	1/4 in	1 1/2 in
Turn Catch Placement- Distance from bottom	RQTI8J	Measure from bottom of bag to bottom edge of turn catch.	true	Full	1/8 in	1 1/4 in
Tab Length	zQn1nh	Lay flat and measure from top edge to peak of fold.	true	Full	1/4 in	1 1/8 in
Tab Width	1Jvubw	Measure edge to edge.	true	Full	0 in	1/2 in
Keychain Height	UPJROm	Lay flat, measure from bottom edge of leather to top edge of swivel hook.	true	Full	1/8 in	4 1/2 in
Keychain Width	VmIPTw	Measure widest point of leather from edge to edge.	true	Full	1/8 in	2 in